

17 Bit, 8 Channel Analogue to Digital Converter with I²C Interface

Introduction

The ADC Pi V2.1 is an 8 channel analogue to digital converter designed for use on the Raspberry Pi computer platform. The board is based around the MCP3424 low noise and high accuracy 17 bit delta-sigma analogue to digital converter from Microchip Technology Inc. A pair of MCP3424 converters are included on the board along with an I²C buffer interface allowing you to connect additional 5V I²C devices to the same bus.

The I²C address bits are selectable using the on-board jumpers. The MCP3424 supports up to 8 different I²C addresses so with two A/D converters on each ADC Pi V2 you can stack up to 4 ADC Pi V2.1 boards on a single Raspberry Pi.

The MCP3424 contains an on-board 2.048V reference voltage which is configured with a voltage divider to give a single ended 0 - 5V input range.

The data rate for analogue to digital conversions is 3.75 (17 bit), 15 (15 bit), 60 (13 bit) or 240 (11 bit) samples per second. Data rate and resolution can be configured within software using the I²C interface.

For more information on the MCP3424 visit Microchips website at <http://www.microchip.com/wwwproducts/Devices.aspx?dDocName=en536354>

Board Layout

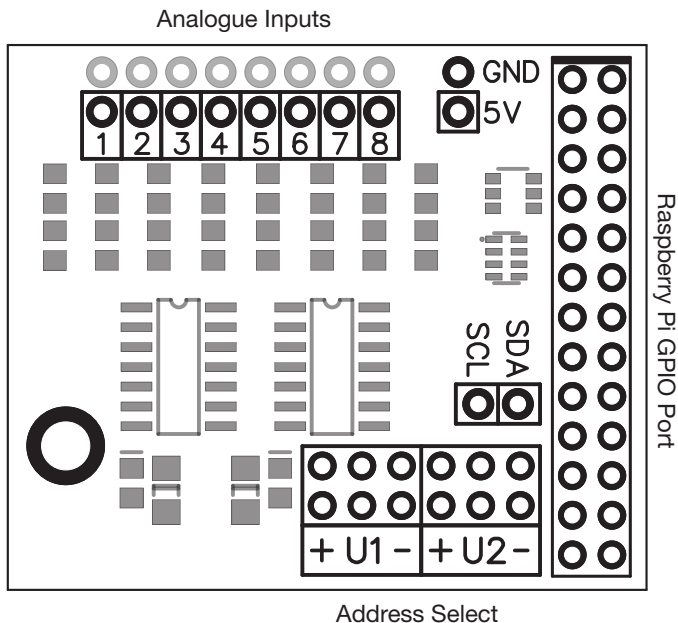

Features

- 8 x 17-bit 0 to 5V Single Ended Inputs
- Control via the Raspberry Pi I²C port
- Stack up to 4 ADC Pi V2 boards on a single Raspberry Pi
- Jumper selectable I²C addresses
- Buffered 5V I²C port
- Based on the MCP3424 from Microchip Technologies Inc
- Single Ended full-scale range of 5.0V
- On-board 2.048V reference voltage (Accuracy $\pm 0.05\%$, Drift: 15 ppm/ $^{\circ}$ C)
- On-Board Programmable Gain Amplifier (PGA):
 - Gains of 1, 2, 4 or 8
- Programmable Data Rate Options:
 - 3.75 SPS (17 bits)
 - 15 SPS (15 bits)
 - 60 SPS (13 bits)
 - 240 SPS (11 bits)
- One-Shot or Continuous Conversion Options

Electrical Characteristics

Vdd (5V pin on I ² C bus).....	5.0V
All AD inputs and outputs.....	VSS-0.4V to VDD+0.4 V
Current at Input Pins.....	± 2 mA
I ² C SDA/SCL voltage.....	5.0 V
I ² C port current.....	100 mA

Installation

To install the ADC Pi simply press the 26 pin connector down onto the Raspberry Pi GPIO pins with the board sat over the top of the Raspberry Pi.

If you are installing more than one ADC Pi on a single Raspberry Pi board then you will need to configure the address select jumpers for each ADC Pi as shown on page 2 of this datasheet.

I²C Address Selection

The MCP3424 analogue to digital converter contains two address select pins which can be tied to Vss, Vdd or left floating. This gives 8 possible I²C addresses for each chip. The ADC Pi V2 contains two MCP3424 chips so you can stack up to 4 ADC Pi V2 boards on a single Raspberry Pi. To simplify address selection on the ADC Pi V2 we have included a set of address selection pins which can be configured using the included jumpers. The illustrations below show the four recommended configurations for your ADC Pi V2 and the associated I²C addresses.

Note:

Disconnect the ADC Pi V2 from the Raspberry Pi before changing the address pins. You may need to short the 5V and ground with a resistor to discharge the capacitors in order for the new addresses to be recognised.

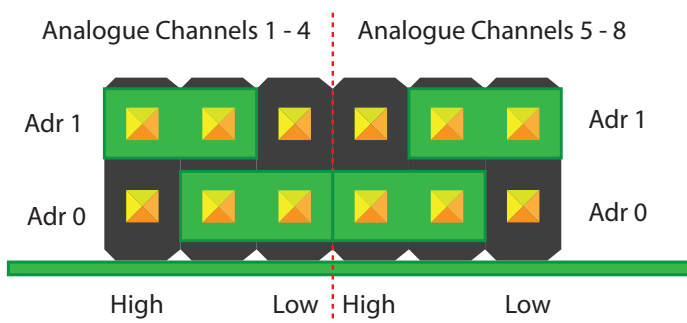

I²C Address Table

Adr 0	Adr 1	I ² C Address
Low or Float	Low or Float	0x68
Low	Float	0x69
Low	High	0x6A
Float	Low	0x6B
High	Low	0x6C
High	Float	0x6D
High	High	0x6E
Float	High	0x6F

Warning

Do not under any circumstances connect the two centre pins together. This will create a direct short between the 5V and ground pins and will damage or destroy your Raspberry Pi and Delta-Sigma board.

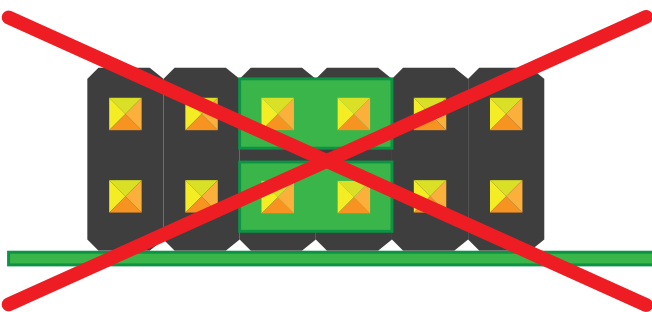

Recommended Address Configurations

Configuration 1:

Analogue Channels 1-4 = I²C Address: 0x68
Analogue Channels 5-8 = I²C Address: 0x69

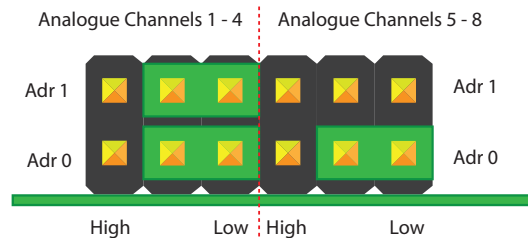

Configuration 2:

Analogue Channels 1-4 = I²C Address: 0x6A
Analogue Channels 5-8 = I²C Address: 0x6B

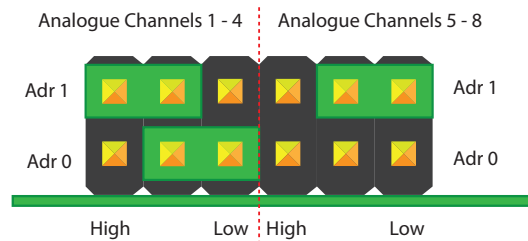

Configuration 3:

Analogue Channels 1-4 = I²C Address: 0x6C
Analogue Channels 5-8 = I²C Address: 0x6D

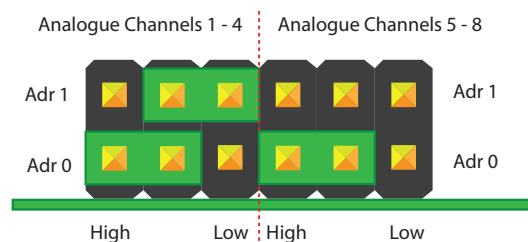

Configuration 4:

Analogue Channels 1-4 = I²C Address: 0x6E
Analogue Channels 5-8 = I²C Address: 0x6F

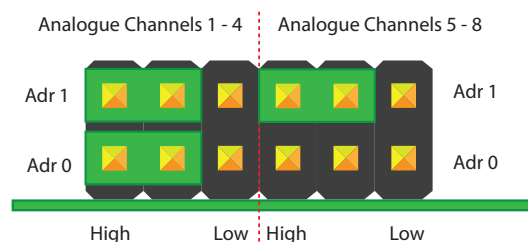

RefDes	Value	Type
C1	100nf	CAP
C2	100nf	CAP
C3	10uF	CAP
C4	10uF	Tantalum
C5	10uF	Tantalum
R1	10K	RES
R2	10K	RES
R3	10K	RES
R4	10K	RES
R5	10K	RES
R6	10K	RES
R7	10K	RES
R8	10K	RES
R13	6.8K	RES
R14	6.8K	RES
R15	6.8K	RES
R16	6.8K	RES
R17	6.8K	RES
R18	6.8K	RES
R19	6.8K	RES
R20	6.8K	RES
R21	10K	CAY16-222J4LF
U1		PI ADC Input
U2	MCP3428	MCP3424
U3	MCP3428	MCP3424
U4		PI ADC 2.1 I2c
U5		Raspberry Pi GPIO
U6		ADC Address Select
U7		FDC6301N

